

LED Vanity Mirror

VM31160-5CCT

INSTALLATION SHEET

START FROM HERE

- Make sure **POWER** is **COMPLETELY OFF** at the fuse box
- Have your mirror installed by a certified licensed electrician
- Prepare everything in a clear area
- Wear gloves at all times during this installation
- Read instructions carefully before you start assembly
- Keep this installation sheet for future reference

Important:

- The installer and/or user must read, understand and follow these instructions before installing the product. This product must be properly installed before it is used. If instructions are not followed, the manufacturer will not be held responsible for any problems or product malfunction. Failure to follow installation and/or operating instructions voids the warranty.

Technical Support: 1-855-855-8926

Please Note:

- This Kuzco LED mirror comes with pre-wired LED module(s)
- Unless instructed, Do Not touch any part of the LED module(s) as any unnecessary contact with the module could cause permanent damage
- For Indoor Use Only
- Touch Dimming
- Do not use alcohol or solvents to clean the mirror
- For your convenience, assembly by two people is a must

1. Remove mirror from its original package
2. Measure, mark location of wall bracket (2a) location, mount to wall with screws (2c) and anchors (2b) (See Illustration 3 for ideal distance measurement) (Note: All screws must be attached directly to stud/structure)
3. Make proper electrical connections (black to hot "L", white to neutral "N", ground to "GND") with wire nuts (1a) provided in hardware package to ON/OFF wall switch (wall switch provided by others)

NOTE: Wall ON/OFF Switch must be used to ensure proper operation of LED mirror

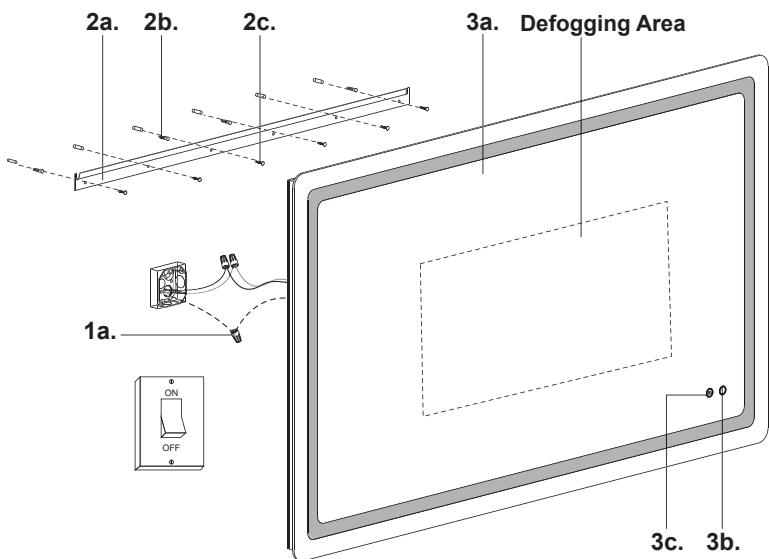

4. Bend both wall bracket (2a) tabs back to prevent mirror from sliding side to side (See Illustration 2). Align mirror (3a) mounting bracket to wall bracket (2a) to secure (See Illustration 1)
5. Tap mirror switch (3b) to choose color temperature and hold to dim up and down. Tap defogging switch (3c) to turn ON/OFF

ILLUSTRATION 1

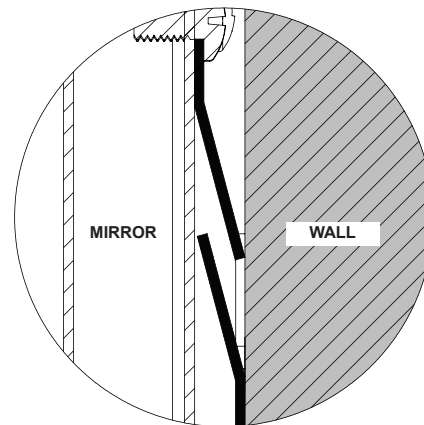

ILLUSTRATION 2

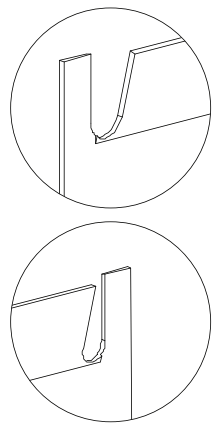
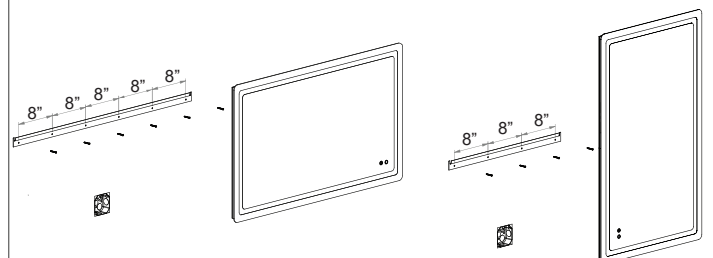

ILLUSTRATION 3

HORIZONTAL MOUNTING

VERTICAL MOUNTING



Note: Ideal distance of drill holes for mirror orientation

LEGEND

- CCT Switch
- ⊗ Defogging Switch
- LED

KUZCO

19054 28th Avenue Surrey, BC Canada V3Z 6M3
 T: 604 538 7162 TF: 1-855 85 KUZCO F: 604 538 7196
 W: kuzcolighting.com
 20240109